

MC14018B

Presettable Divide-By-N Counter

The MC14018B contains five Johnson counter stages which are asynchronously presettable and resettable. The counters are synchronous, and increment on the positive going edge of the clock.

Presetting is accomplished by a logic 1 on the preset enable input. Data on the Jam inputs will then be transferred to their respective \bar{Q} outputs (inverted). A logic 1 on the reset input will cause all \bar{Q} outputs to go to a logic 1 state.

Division by any number from 2 to 10 can be accomplished by connecting appropriate \bar{Q} outputs to the data input, as shown in the Function Selection table. Anti-lock gating is included in the MC14018B to assure proper counting sequence.

Features

- Fully Static Operation
- Schmitt Trigger on Clock Input
- Capable of Driving Two Low-Power TTL Loads or One Low-Power Schottky TTL Load Over the Rated Temperature Range
- Pin-for-Pin Replacement for CD4018B
- Pb-Free Packages are Available*

MAXIMUM RATINGS (Voltages Referenced to V_{SS})

Symbol	Parameter	Value	Unit
V_{DD}	DC Supply Voltage Range	-0.5 to +18.0	V
V_{in}, V_{out}	Input or Output Voltage Range (DC or Transient)	-0.5 to $V_{DD} + 0.5$	V
I_{in}, I_{out}	Input or Output Current (DC or Transient) per Pin	± 10	mA
P_D	Power Dissipation, per Package (Note 1)	500	mW
T_A	Ambient Temperature Range	-55 to +125	°C
T_{stg}	Storage Temperature Range	-65 to +150	°C
T_L	Lead Temperature (8-Second Soldering)	260	°C

Maximum ratings are those values beyond which device damage can occur. Maximum ratings applied to the device are individual stress limit values (not normal operating conditions) and are not valid simultaneously. If these limits are exceeded, device functional operation is not implied, damage may occur and reliability may be affected.

1. Temperature Derating:

Plastic "P and D/DW" Packages: - 7.0 mW/°C From 65°C To 125°C

This device contains protection circuitry to guard against damage due to high static voltages or electric fields. However, precautions must be taken to avoid applications of any voltage higher than maximum rated voltages to this high-impedance circuit. For proper operation, V_{in} and V_{out} should be constrained to the range $V_{SS} \leq (V_{in} \text{ or } V_{out}) \leq V_{DD}$.

Unused inputs must always be tied to an appropriate logic voltage level (e.g., either V_{SS} or V_{DD}). Unused outputs must be left open.

*For additional information on our Pb-Free strategy and soldering details, please download the ON Semiconductor Soldering and Mounting Techniques Reference Manual, SOLDERRM/D.



ON Semiconductor®

<http://onsemi.com>

MARKING DIAGRAMS

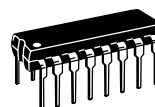

PDIP-16
P SUFFIX
CASE 648

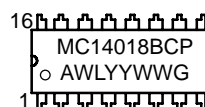

SOIC-16
D SUFFIX
CASE 751B

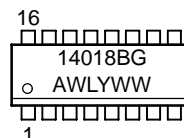

A = Assembly Location
WL, L = Wafer Lot
YY, Y = Year
WW, W = Work Week
G = Pb-Free Indicator

ORDERING INFORMATION



See detailed ordering and shipping information in the package dimensions section on page 2 of this data sheet.

MC14018B

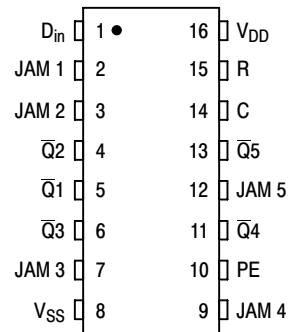
PIN ASSIGNMENT



FUNCTIONAL TRUTH TABLE

Clock	Reset	Preset Enable	Jam Input	\bar{Q}_n
	0	0	X	\bar{Q}_n
	0	0	X	\bar{D}_n^*
X	0	1	0	1
X	0	1	1	0
X	1	X	X	1

*D_n is the Data input for that stage. Stage 1 has Data brought out to Pin 1.

ORDERING INFORMATION

Device	Package	Shipping [†]
MC14018BCP	PDIP-16	500 Units / Rail
MC14018BCPG	PDIP-16 (Pb-Free)	500 Units / Rail
MC14018BD	SOIC-16	48 Units / Rail
MC14018BDG	SOIC-16 (Pb-Free)	48 Units / Rail
MC14018BDR2	SOIC-16	2500 Units / Tape & Reel
MC14018BDR2G	SOIC-16 (Pb-Free)	2500 Units / Tape & Reel

[†]For information on tape and reel specifications, including part orientation and tape sizes, please refer to our Tape and Reel Packaging Specifications Brochure, BRD8011/D.

MC14018B

ELECTRICAL CHARACTERISTICS (Voltages Referenced to V_{SS})

Characteristic	Symbol	V _{DD} Vdc	- 55° C		25° C			125° C		Unit	
			Min	Max	Min	Typ (Note 2)	Max	Min	Max		
Output Voltage V _{in} = V _{DD} or 0 V _{in} = 0 or V _{DD}	"0" Level "1" Level	V _{OL}	5.0	—	0.05	—	0	0.05	—	0.05	Vdc
			10	—	0.05	—	0	0.05	—	0.05	
			15	—	0.05	—	0	0.05	—	0.05	
			5.0	4.95	—	4.95	5.0	—	4.95	—	Vdc
			10	9.95	—	9.95	10	—	9.95	—	
			15	14.95	—	14.95	15	—	14.95	—	
Input Voltage (V _O = 4.5 or 0.5 Vdc) (V _O = 9.0 or 1.0 Vdc) (V _O = 13.5 or 1.5 Vdc)	"0" Level	V _{IL}	5.0	—	1.5	—	2.25	1.5	—	1.5	Vdc
			10	—	3.0	—	4.50	3.0	—	3.0	
			15	—	4.0	—	6.75	4.0	—	4.0	
(V _O = 0.5 or 4.5 Vdc) (V _O = 1.0 or 9.0 Vdc) (V _O = 1.5 or 13.5 Vdc)	"1" Level	V _{IH}	5.0	3.5	—	3.5	2.75	—	3.5	—	Vdc
			10	7.0	—	7.0	5.50	—	7.0	—	
			15	11	—	11	8.25	—	11	—	
Output Drive Current (V _{OH} = 2.5 Vdc) (V _{OH} = 4.6 Vdc) (V _{OH} = 9.5 Vdc) (V _{OH} = 13.5 Vdc)	Source	I _{OH}	5.0	- 3.0	—	- 2.4	- 4.2	—	- 1.7	—	mAdc
			5.0	- 0.64	—	- 0.51	- 0.88	—	- 0.36	—	
			10	- 1.6	—	- 1.3	- 2.25	—	- 0.9	—	
			15	- 4.2	—	- 3.4	- 8.8	—	- 2.4	—	
(V _{OL} = 0.4 Vdc) (V _{OL} = 0.5 Vdc) (V _{OL} = 1.5 Vdc)	Sink	I _{OL}	5.0	0.64	—	0.51	0.88	—	0.36	—	mAdc
			10	1.6	—	1.3	2.25	—	0.9	—	
			15	4.2	—	3.4	8.8	—	2.4	—	
Input Current	I _{in}	15	—	± 0.1	—	± 0.00001	± 0.1	—	± 1.0	μAdc	
Input Capacitance (V _{in} = 0)	C _{in}	—	—	—	—	5.0	7.5	—	—	pF	
Quiescent Current (Per Package)	I _{DD}	5.0	—	5.0	—	0.005	5.0	—	150	μAdc	
		10	—	10	—	0.010	10	—	300		
		15	—	20	—	0.015	20	—	600		
Total Supply Current (Notes 3 & 4) (Dynamic plus Quiescent, Per Package) (C _L = 50 pF on all outputs, all buffers switching)	I _T	5.0	I _T = (0.3 μA/kHz) f + I _{DD} I _T = (0.7 μA/kHz) f + I _{DD} I _T = (1.0 μA/kHz) f + I _{DD}							μAdc	
		10									
		15									

2. Data labelled "Typ" is not to be used for design purposes but is intended as an indication of the IC's potential performance.

3. The formulas given are for the typical characteristics only at 25° C.

4. To calculate total supply current at loads other than 50 pF:

$$I_T(C_L) = I_T(50 \text{ pF}) + (C_L - 50) \text{ Vfk}$$

where: I_T is in μA (per package), C_L in pF, V = (V_{DD} - V_{SS}) in volts, f in kHz is input frequency, and k = 0.001.

MC14018B

SWITCHING CHARACTERISTICS (Note 5) ($C_L = 50$ pF, $T_A = 25^\circ\text{C}$)

Characteristic	Symbol	V_{DD} Vdc	All Types			Unit
			Min	Typ (Note 6)	Max	
Output Rise and Fall Time $t_{TLH}, t_{THL} = (1.35 \text{ ns/pF}) C_L + 32 \text{ ns}$ $t_{TLH}, t_{THL} = (0.6 \text{ ns/pF}) C_L + 20 \text{ ns}$ $t_{TLH}, t_{THL} = (0.4 \text{ ns/pF}) C_L + 20 \text{ ns}$	t_{TLH}, t_{THL}	5.0 10 15	— — —	100 50 40	200 100 80	ns
Propagation Delay Time Clock to \bar{Q} $t_{PLH}, t_{PHL} = (0.90 \text{ ns/pF}) C_L + 265 \text{ ns}$ $t_{PLH}, t_{PHL} = (0.36 \text{ ns/pF}) C_L + 102 \text{ ns}$ $t_{PLH}, t_{PHL} = (0.26 \text{ ns/pF}) C_L + 72 \text{ ns}$	t_{PLH}, t_{PHL}	5.0 10 15	— — —	310 120 85	620 240 170	ns
Reset to \bar{Q} $t_{PLH} = (0.90 \text{ ns/pF}) C_L + 325 \text{ ns}$ $t_{PLH} = (0.36 \text{ ns/pF}) C_L + 132 \text{ ns}$ $t_{PLH} = (0.26 \text{ ns/pF}) C_L + 81 \text{ ns}$		5.0 10 15	— — —	370 150 100	740 300 200	ns
Preset Enable to \bar{Q} $t_{PLH}, t_{PHL} = (0.90 \text{ ns/pF}) C_L + 325 \text{ ns}$ $t_{PLH}, t_{PHL} = (0.36 \text{ ns/pF}) C_L + 132 \text{ ns}$ $t_{PLH}, t_{PHL} = (0.26 \text{ ns/pF}) C_L + 81 \text{ ns}$		5.0 10 15	— — —	370 150 100	740 300 200	ns
Setup Time Data (Pin 1) to Clock	t_{su}	5.0 10 15	200 100 80	0 0 0	— — —	ns
Jam Inputs to Preset Enable		5.0 10 15	200 100 80	0 0 0	— — —	ns
Data (Jam Inputs)-to-Preset Enable Hold Time	t_h	5.0 10 15	540 500 480	270 250 240	— — —	ns
Clock Pulse Width	t_{WH}	5.0 10 15	400 200 160	200 100 80	— — —	ns
Reset or Preset Enable Pulse Width	t_{WH}	5.0 10 15	290 130 110	145 65 55	— — —	ns
Clock Rise and Fall Time	t_{TLH}, t_{THL}	5.0 10 15	No Limit			ns
Clock Pulse Frequency	f_{cl}	5.0 10 15	— — —	2.5 6.5 8.0	1.25 3.25 4.0	MHz

5. The formulas given are for the typical characteristics only at 25°C .

6. Data labelled "Typ" is not to be used for design purposes but is intended as an indication of the IC's potential performance.

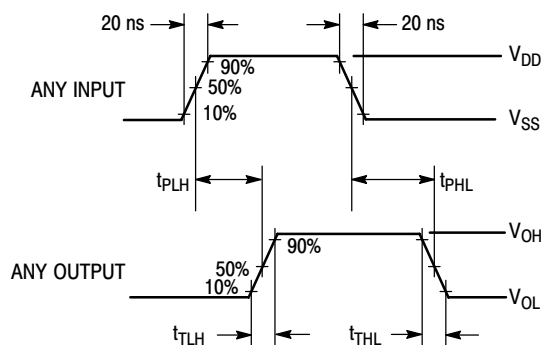
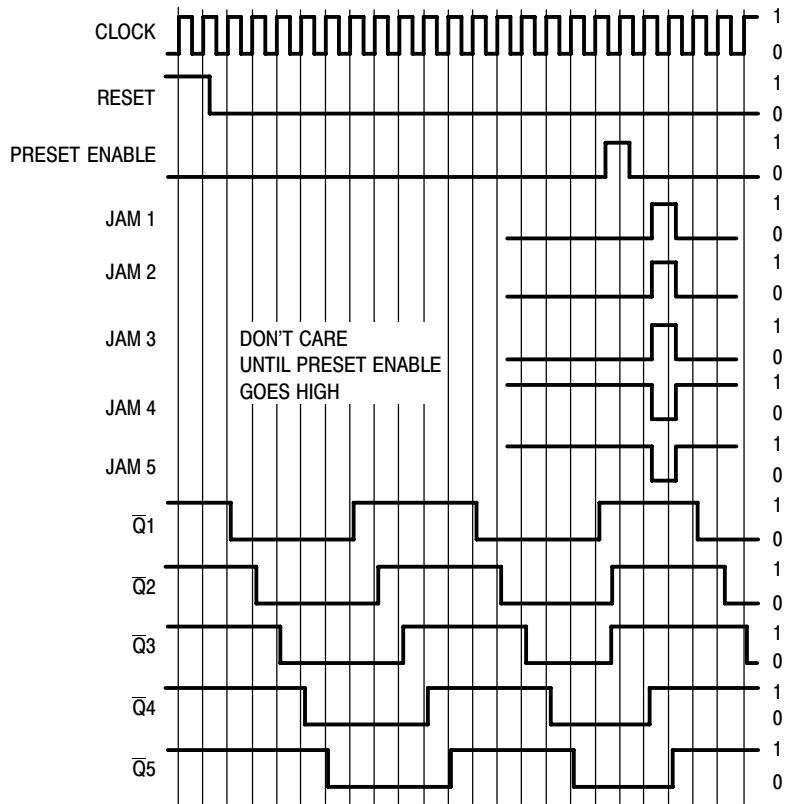

Figure 1. Switching Time Waveforms

MC14018B

TIMING DIAGRAM
($\bar{Q}5$ Connected to Data Input)



FUNCTION SELECTION

Counter Mode	Connect Data Input (Pin 1) to:	Comments
Divide by 10 Divide by 8 Divide by 6 Divide by 4 Divide by 2	$\bar{Q}5$ $\bar{Q}4$ $\bar{Q}3$ $\bar{Q}2$ $\bar{Q}1$	No external components needed.
Divide by 9 Divide by 7 Divide by 5 Divide by 3	$Q5 \cdot Q4$ $Q4 \cdot Q3$ $Q3 \cdot Q2$ $Q2 \cdot Q1$	Gate package needed to provide AND function. Counter Skips all 1's state

LOGIC DIAGRAM

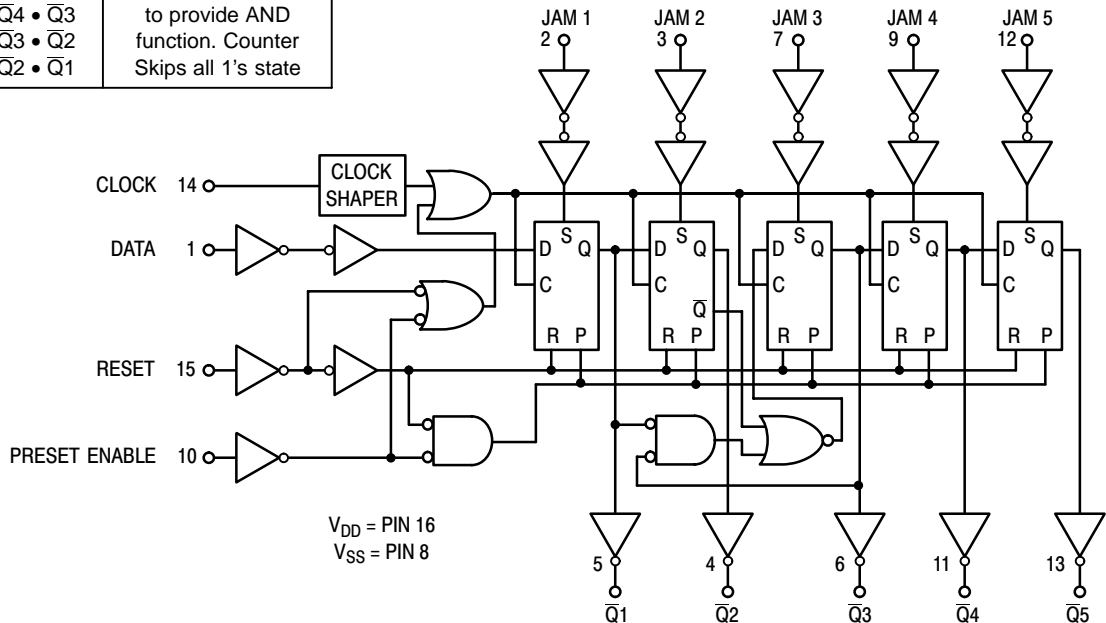

MC14018B

PACKAGE DIMENSIONS

PDIP-16
P SUFFIX
PLASTIC DIP PACKAGE
CASE 648-08
ISSUE T

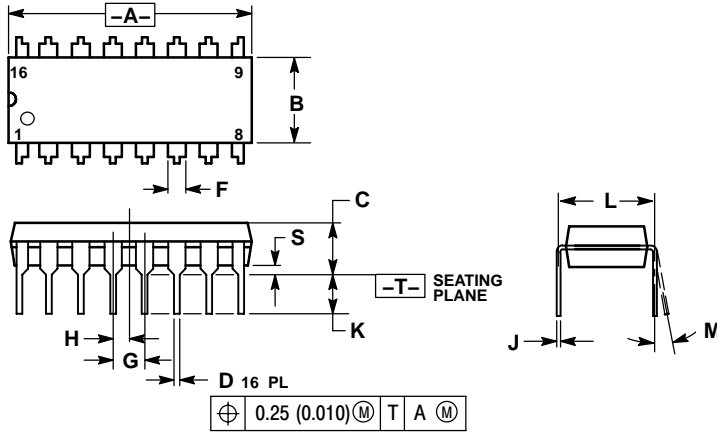

NOTES:

1. DIMENSIONING AND TOLERANCING PER ANSI Y14.5M, 1982.
2. CONTROLLING DIMENSION: INCH.
3. DIMENSION L TO CENTER OF LEADS WHEN FORMED PARALLEL.
4. DIMENSION B DOES NOT INCLUDE MOLD FLASH.
5. ROUNDED CORNERS OPTIONAL.

DIM	INCHES		MILLIMETERS	
	MIN	MAX	MIN	MAX
A	0.740	0.770	18.80	19.55
B	0.250	0.270	6.35	6.85
C	0.145	0.175	3.69	4.44
D	0.015	0.021	0.39	0.53
F	0.040	0.70	1.02	1.77
G	0.100 BSC		2.54 BSC	
H	0.050 BSC		1.27 BSC	
J	0.008	0.015	0.21	0.38
K	0.110	0.130	2.80	3.30
L	0.295	0.305	7.50	7.74
M	0°	10°	0°	10°
S	0.020	0.040	0.51	1.01

MC14018B

PACKAGE DIMENSIONS

SOIC-16
D SUFFIX
PLASTIC SOIC PACKAGE
CASE 751B-05
ISSUE J

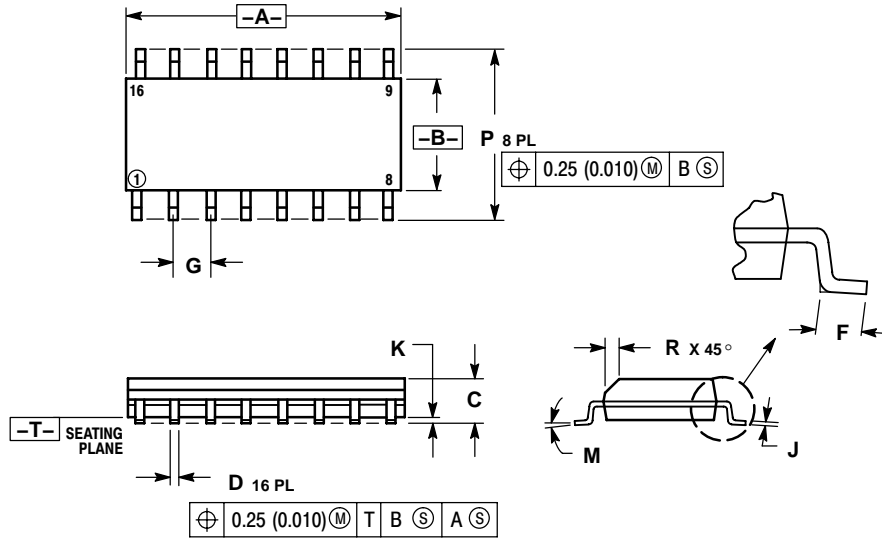

NOTES:

1. DIMENSIONING AND TOLERANCING PER ANSI Y14.5M, 1982.
2. CONTROLLING DIMENSION: MILLIMETER.
3. DIMENSIONS A AND B DO NOT INCLUDE MOLD PROTRUSION.
4. MAXIMUM MOLD PROTRUSION 0.15 (0.006) PER SIDE.
5. DIMENSION D DOES NOT INCLUDE DAMBAR PROTRUSION. ALLOWABLE DAMBAR PROTRUSION SHALL BE 0.127 (0.005) TOTAL IN EXCESS OF THE D DIMENSION AT MAXIMUM MATERIAL CONDITION.

DIM	MILLIMETERS		INCHES	
	MIN	MAX	MIN	MAX
A	9.80	10.00	0.386	0.393
B	3.80	4.00	0.150	0.157
C	1.35	1.75	0.054	0.068
D	0.35	0.49	0.014	0.019
F	0.40	1.25	0.016	0.049
G	1.27 BSC		0.050 BSC	
J	0.19	0.25	0.008	0.009
K	0.10	0.25	0.004	0.009
M	0°	7°	0°	7°
P	5.80	6.20	0.229	0.244
R	0.25	0.50	0.010	0.019

MC14018B

ON Semiconductor and **ON** are registered trademarks of Semiconductor Components Industries, LLC (SCILLC). SCILLC reserves the right to make changes without further notice to any products herein. SCILLC makes no warranty, representation or guarantee regarding the suitability of its products for any particular purpose, nor does SCILLC assume any liability arising out of the application or use of any product or circuit, and specifically disclaims any and all liability, including without limitation special, consequential or incidental damages. "Typical" parameters which may be provided in SCILLC data sheets and/or specifications can and do vary in different applications and actual performance may vary over time. All operating parameters, including "Typicals" must be validated for each customer application by customer's technical experts. SCILLC does not convey any license under its patent rights nor the rights of others. SCILLC products are not designed, intended, or authorized for use as components in systems intended for surgical implant into the body, or other applications intended to support or sustain life, or for any other application in which the failure of the SCILLC product could create a situation where personal injury or death may occur. Should Buyer purchase or use SCILLC products for any such unintended or unauthorized application, Buyer shall indemnify and hold SCILLC and its officers, employees, subsidiaries, affiliates, and distributors harmless against all claims, costs, damages, and expenses, and reasonable attorney fees arising out of, directly or indirectly, any claim of personal injury or death associated with such unintended or unauthorized use, even if such claim alleges that SCILLC was negligent regarding the design or manufacture of the part. SCILLC is an Equal Opportunity/Affirmative Action Employer. This literature is subject to all applicable copyright laws and is not for resale in any manner.

PUBLICATION ORDERING INFORMATION

LITERATURE FULFILLMENT:

Literature Distribution Center for ON Semiconductor
P.O. Box 61312, Phoenix, Arizona 85082-1312 USA
Phone: 480-829-7710 or 800-344-3860 Toll Free USA/Canada
Fax: 480-829-7709 or 800-344-3867 Toll Free USA/Canada
Email: orderlit@onsemi.com

N. American Technical Support: 800-282-9855 Toll Free
USA/Canada

Japan: ON Semiconductor, Japan Customer Focus Center
2-9-1 Kamimeguro, Meguro-ku, Tokyo, Japan 153-0051
Phone: 81-3-5773-3850

ON Semiconductor Website: <http://onsemi.com>

Order Literature: <http://www.onsemi.com/litorder>

For additional information, please contact your
local Sales Representative.